

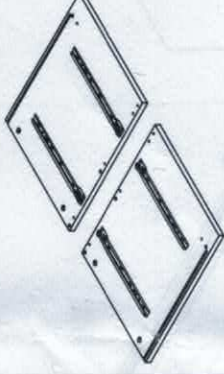

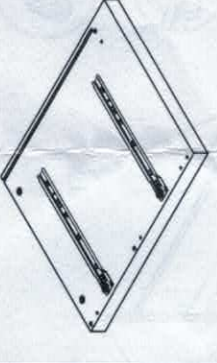



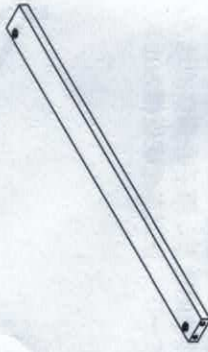

<p>①顶板 1×</p> 	<p>②左/右侧板 2×</p> 	<p>③间板 1×</p> 	<p>④底拉条 2×</p> 	<p>A. 木榫 22× B. 三合一锁扣 38+1× C. 三合一螺杆 38+1× D. 环美贴 38×</p> 	<p>⑤档条 6×</p> 	<p>⑥背板 2×</p> 	<p>⑦抽面板 4×</p> 	<p>⑧右抽侧板 4×</p> 	<p>E. 背板支架 12× F. 螺丝刀 1× G. 快牙自攻钉 16×</p> 	<p>⑨左抽侧板 1×</p> 	<p>⑩抽后板 4×</p> 	<p>⑪抽底板 4×</p> 	<p>⑫背板 4×</p> 	<p>⑬背板 4×</p> 	<p>品名: GF543-1605A 规格: 1600W*400D*495H 客服: 400-870-9808</p>
															
<p>志光家具集团 GF543-1605A 共3页 第1页</p>															

志光

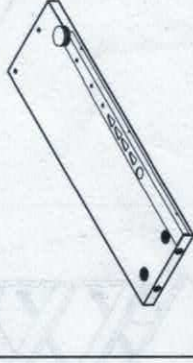
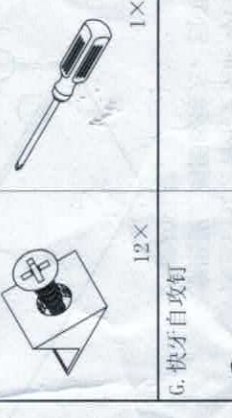
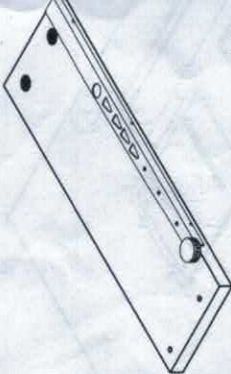
品名: GF543-1605A
规格: 1600W*400D*495H
客服: 400-870-9808

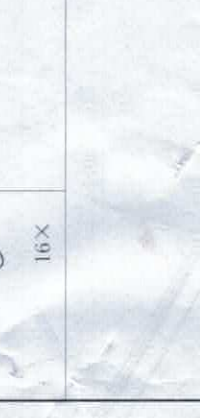
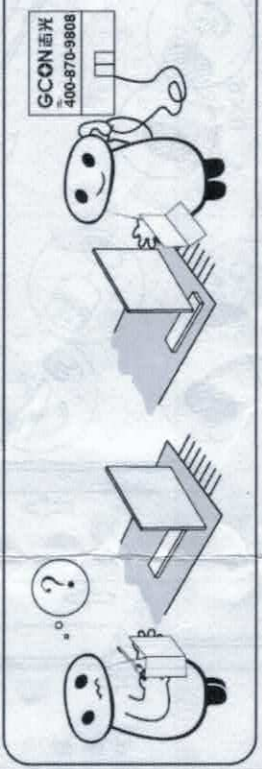
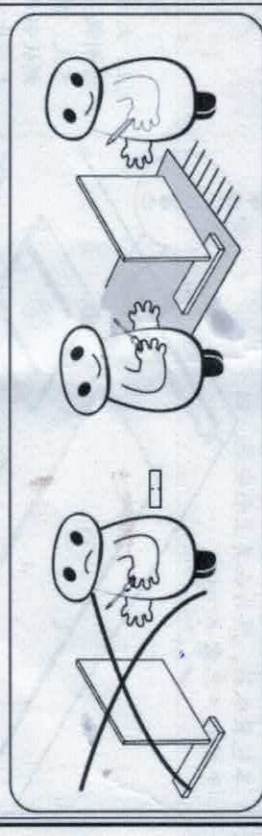
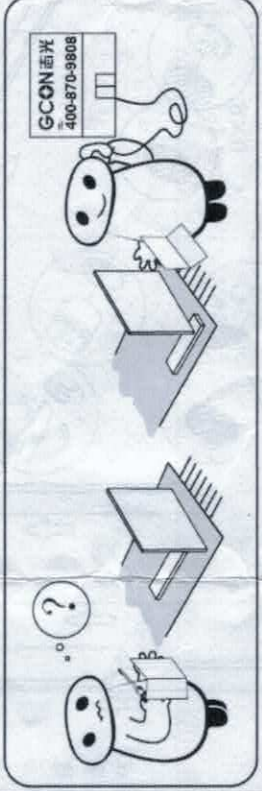

步骤 1

注：安装时请在地面上垫一块毯子或以本包装纸箱，然后在其上面安装，以免擦伤产品零部件！

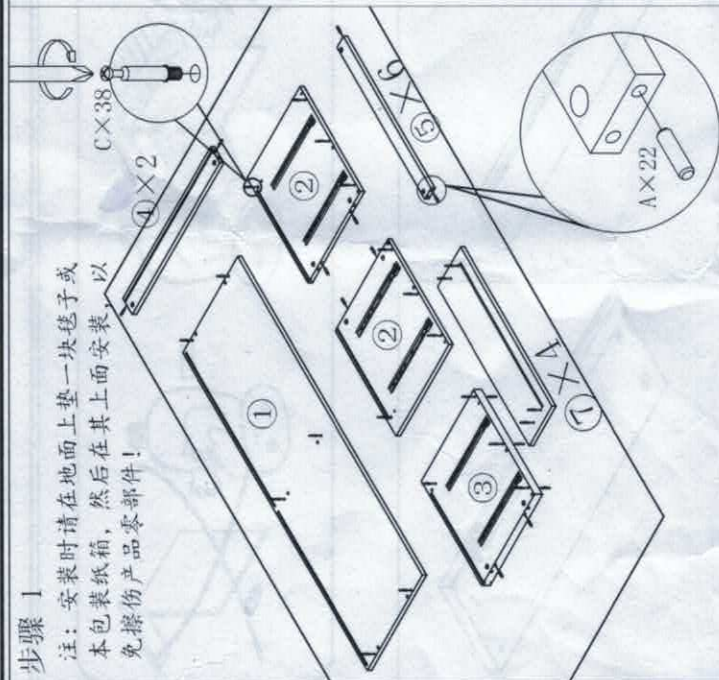

步骤 2

注：此为左
边侧板安装
方式，右边
侧板安装方
式与此方法
一样

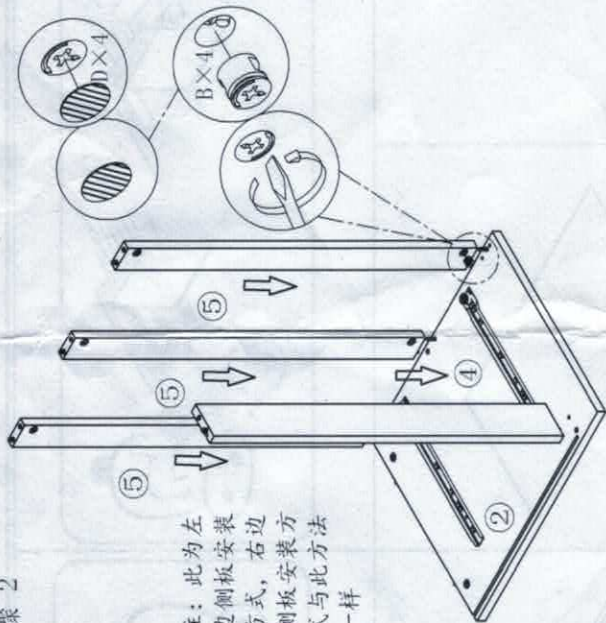

步骤 3

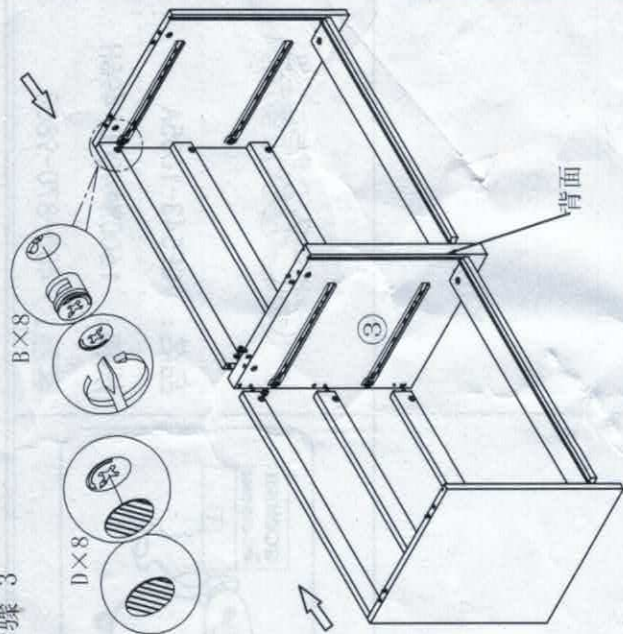

步骤 4

注：安装背板时两边要卡进背板槽，并沿着背板槽慢慢按下来，如果有偏移槽的地方，用手在偏移的地方两面按一下，直到卡进底板槽为止。

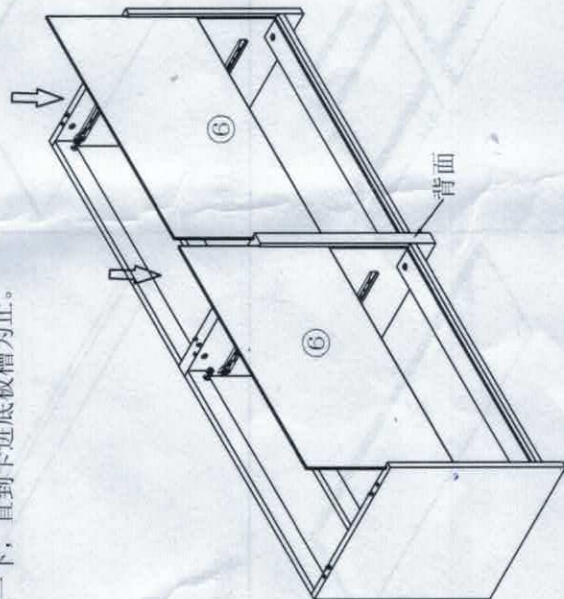

步骤 5

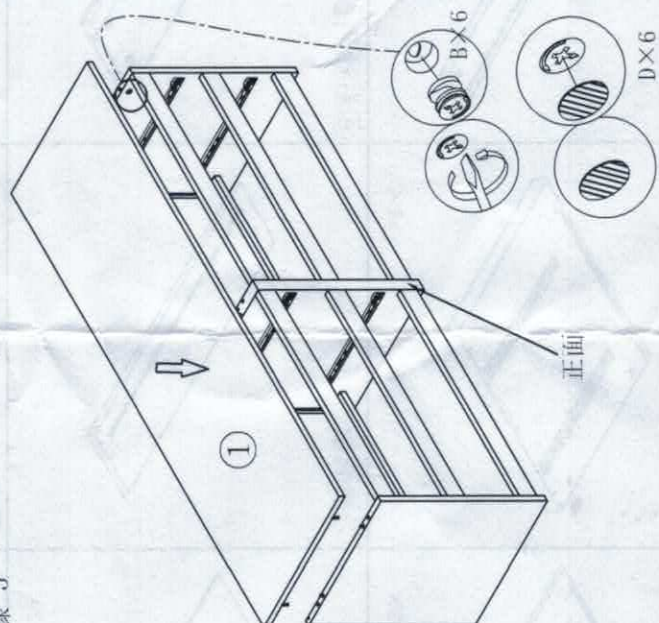

步骤 6

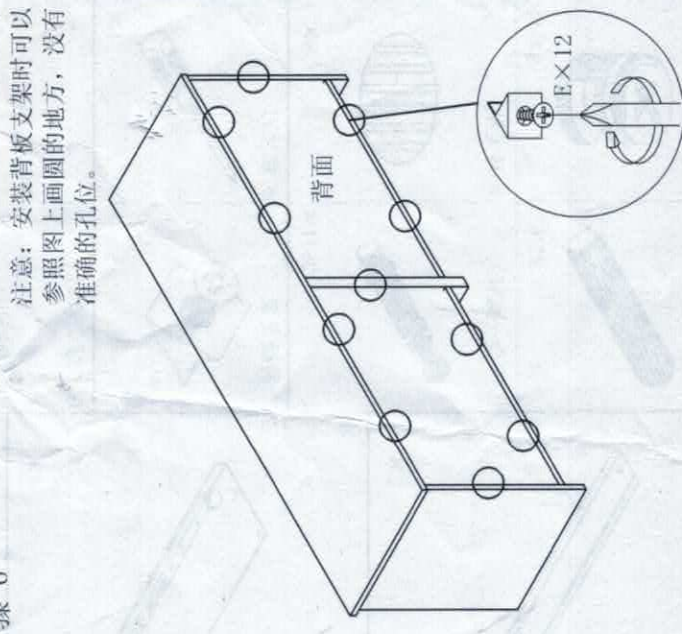

注意：安装背板支架时可以参照图上画圆的地方，没有准确的孔位。

步骤 7

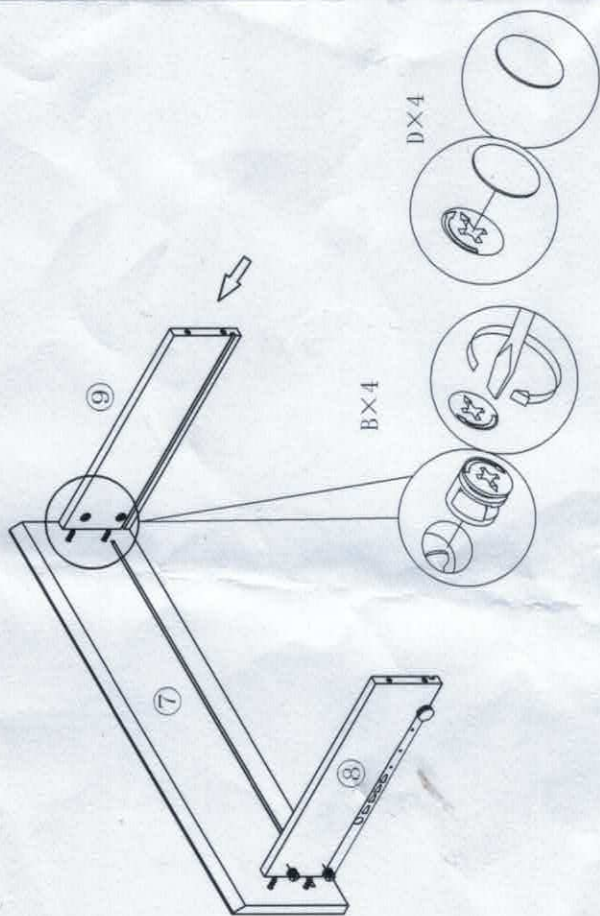

步骤 8

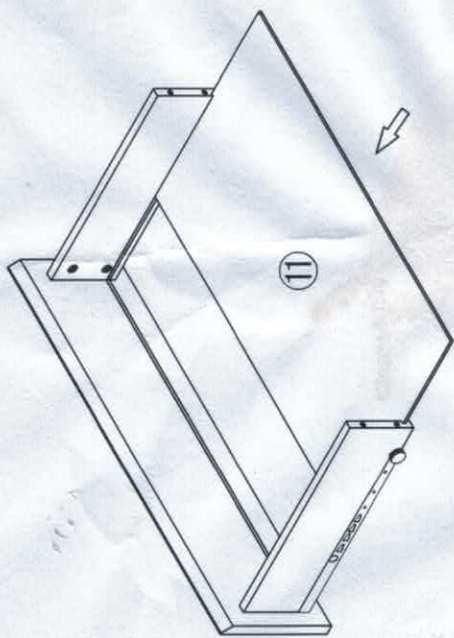

步骤 9

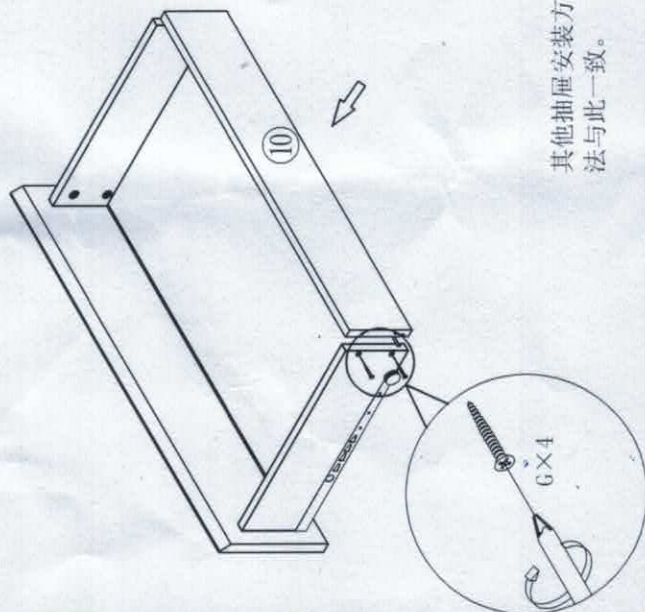

其他抽屉安装方
法与此一致。

步骤 10

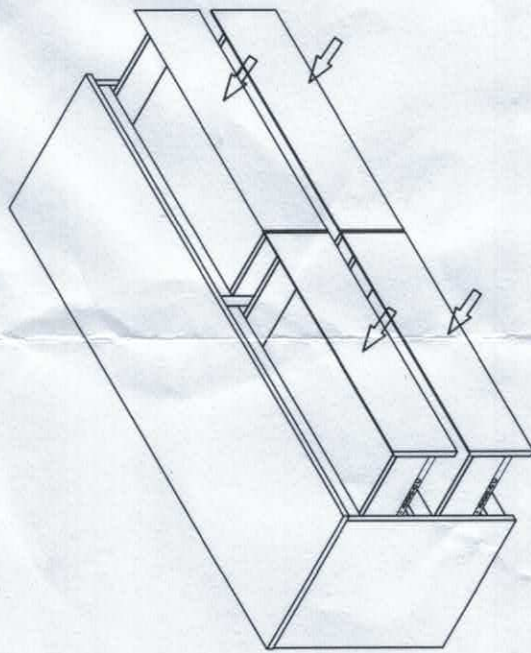

步骤 11

